

Installation instructions for PZ4AL-2793-00, PZ4AL-2794-00
Under Run Protective Shield Fuel Tank

TOYOTA RAV4



LEXUS NX



Model year:

RAV4 - 2012 - 2015 -

NX

2014

Applicability:

ZSA44L-ANFXK; ZSA44L-ANXXK
ZSA44L-ANXGK; ZSA44L-ANYXKX
ZSA44L-ANYMKX; ALA49L-ANTGXX
ASA44L-ANTGKX; ASA44L-ANTMKX
ALA49L-ANTMXX; ZSA42L-ANYXKX
ZSA44L-ANFMKX; ZSA42L-ANYMKX
ZSA42L-ANFXKX; ALA49L-ANTGYW

all sfx
except NX300h

Part Number:

Steel: PZ4AL-2793-00
Aluminium: PZ4AL-2794-00



Weight:

Steel: 14.10 kg
Aluminium: 10.09 kg



Installation Time:

30 min

Rev.1 12.10.2015

PZ4AL-02793-00, PZ4AL-02794-00

A

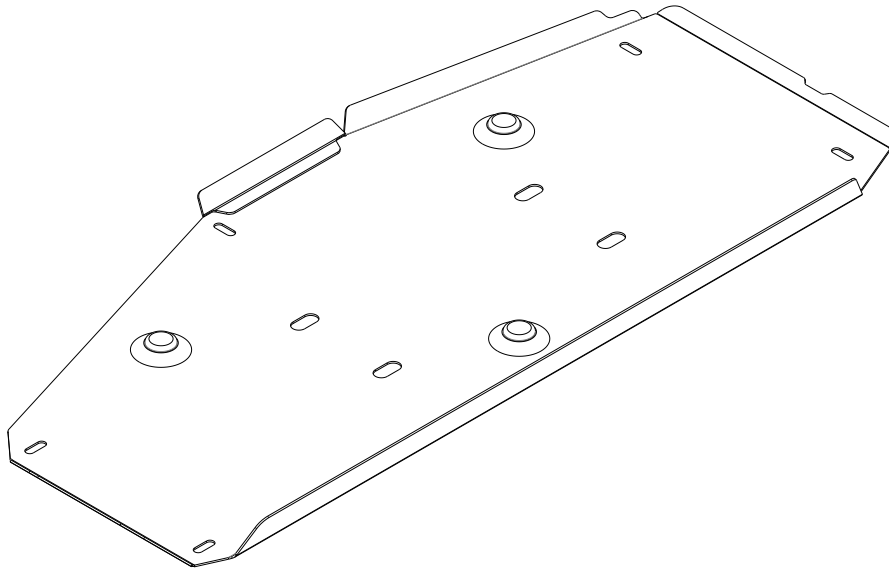

PZ4AL-02793-60

B

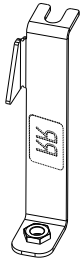

1x

C



1x

D

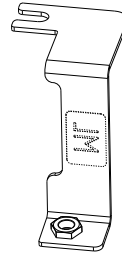

1x

E

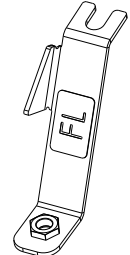

1x

F

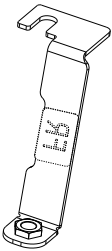

1x

G

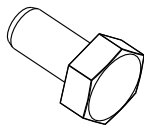

M10x30

5x

H



d=10

5x

I

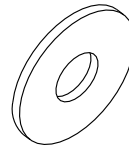

d=10

5x

J

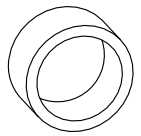

h=10

1x

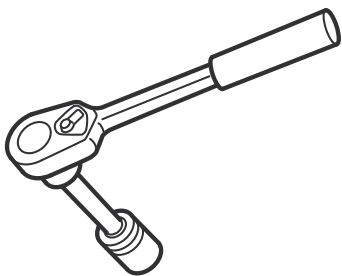

17 mm

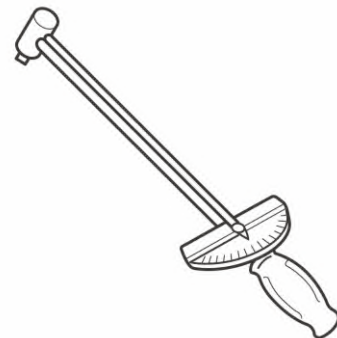

1

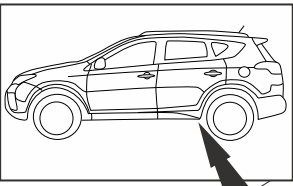

FWD

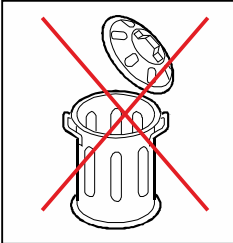
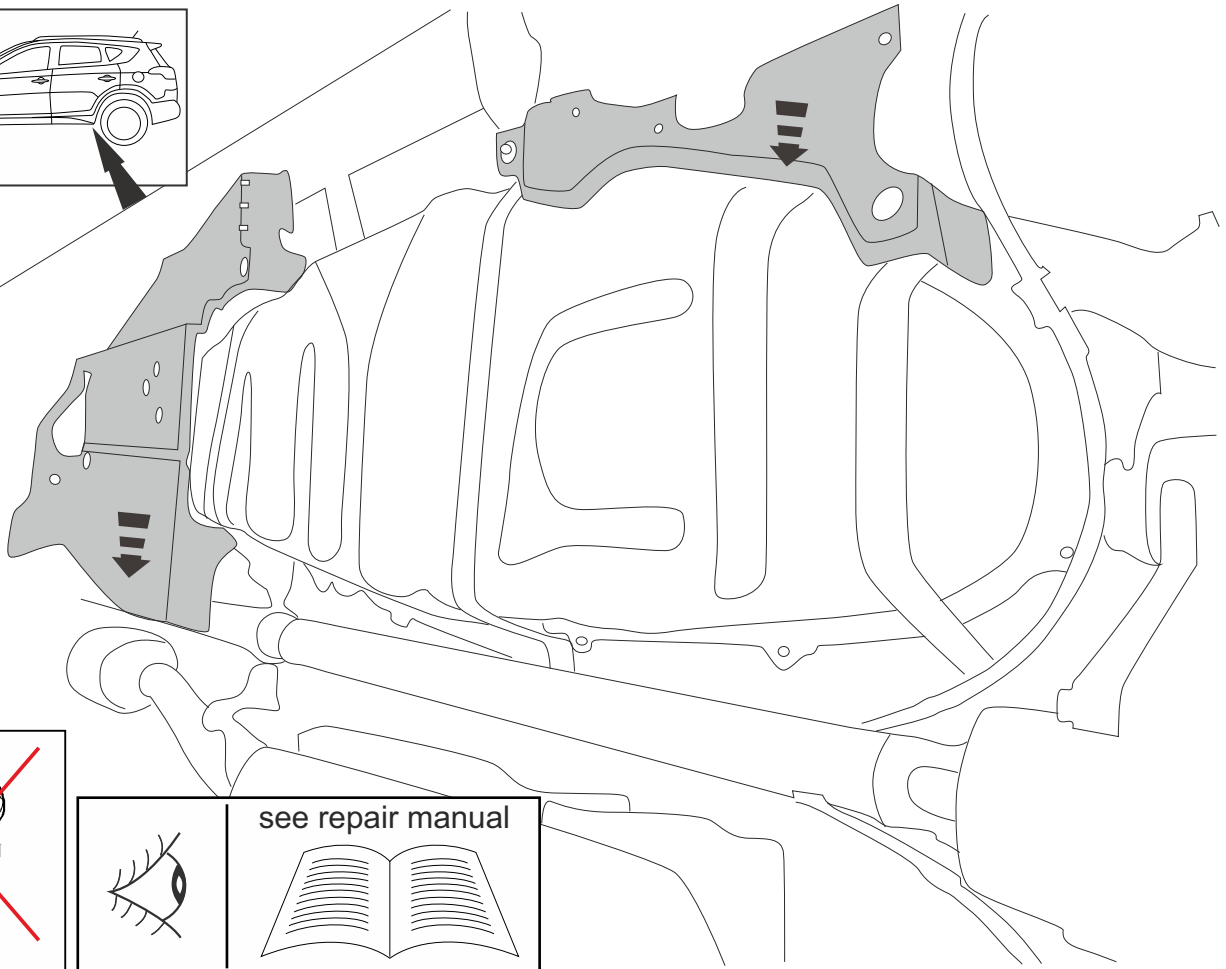

see repair manual

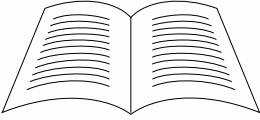
2

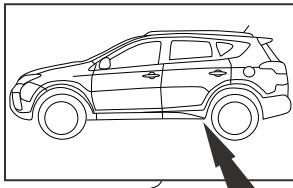

FWD

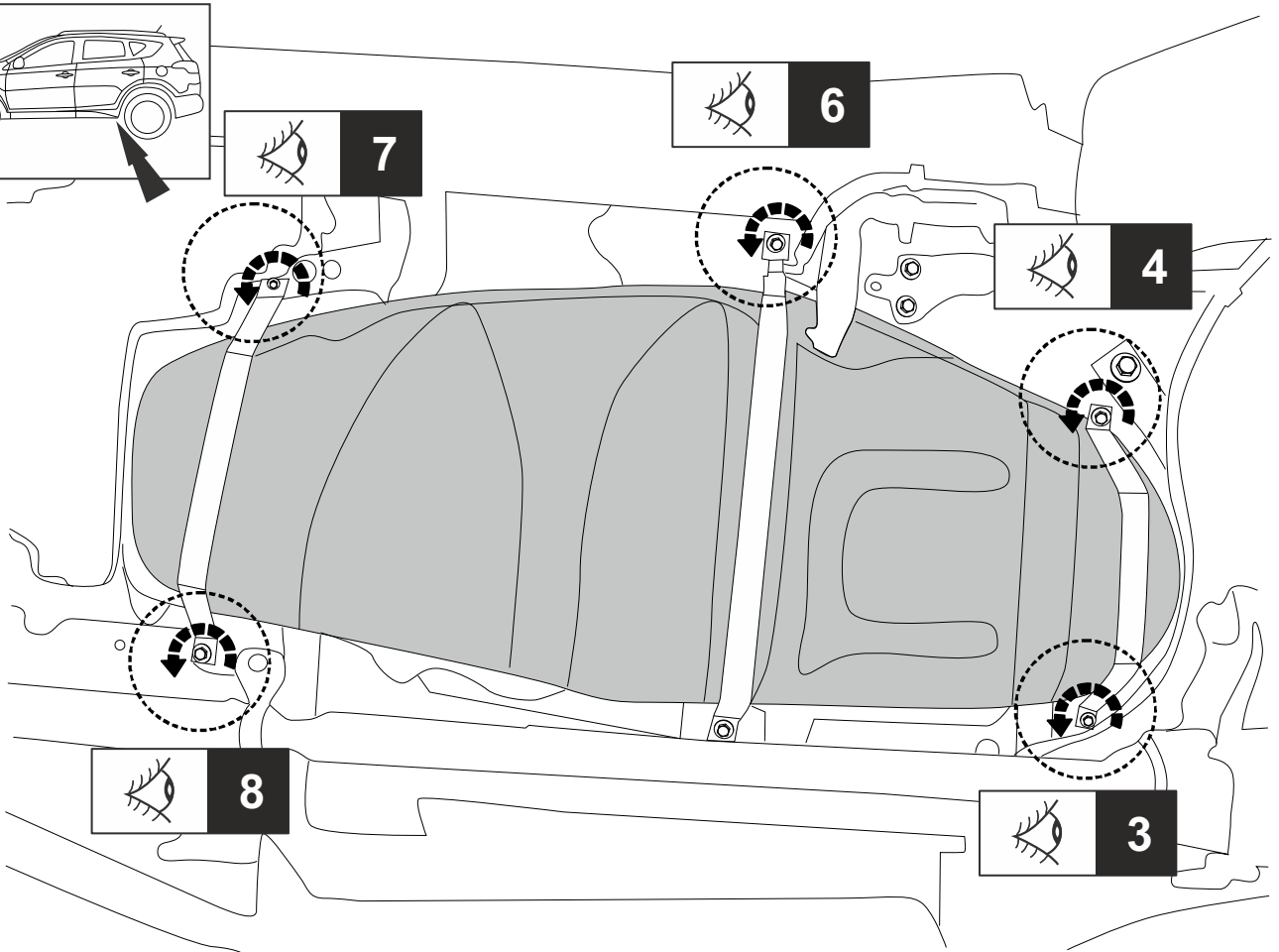

3

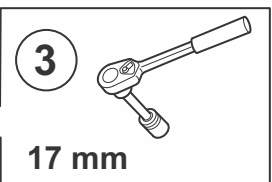
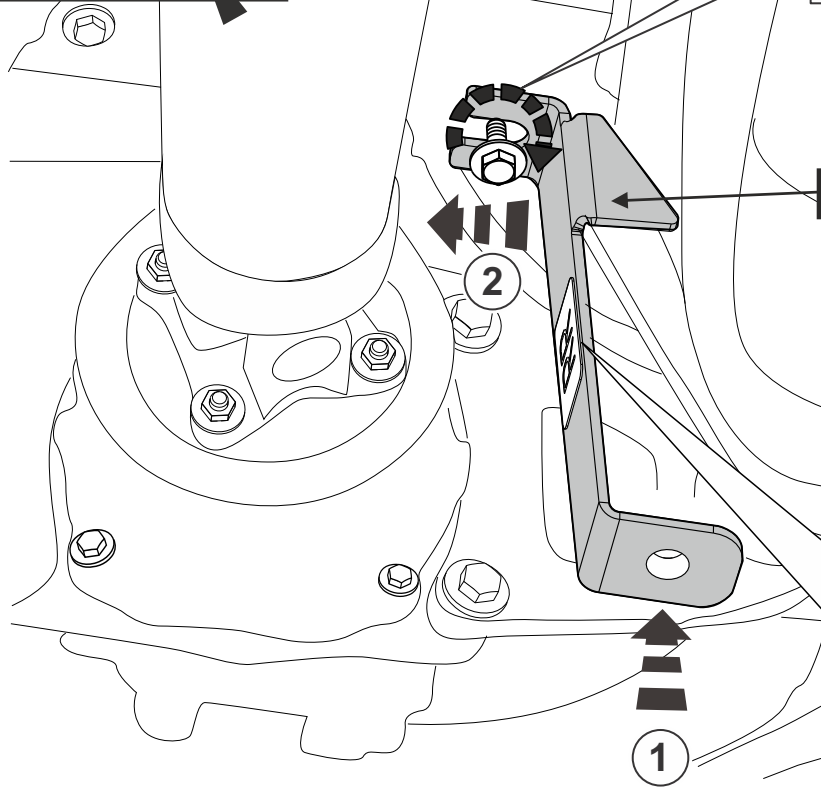
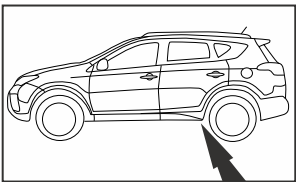

4

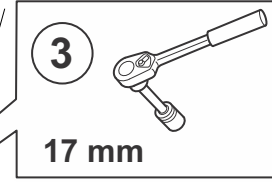
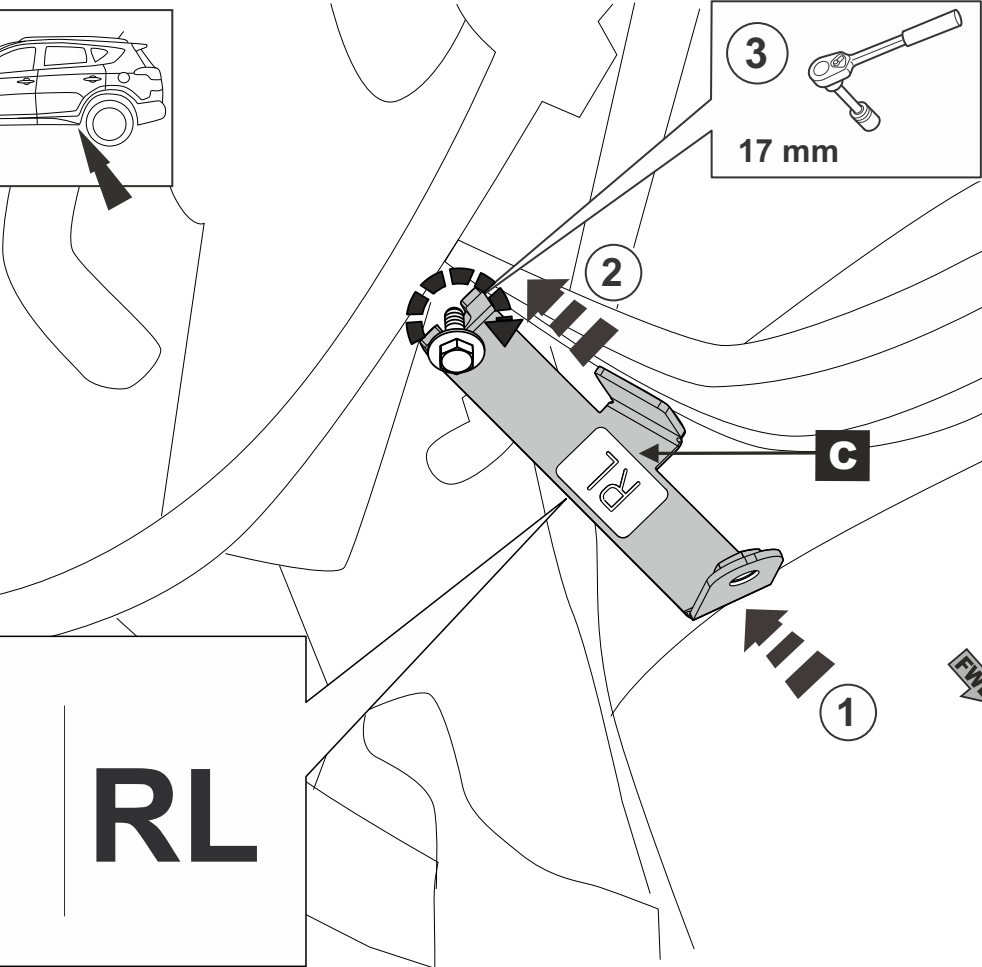
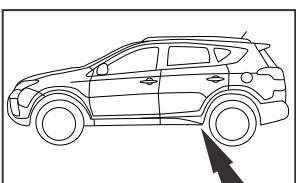

5

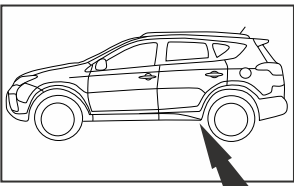

FWD

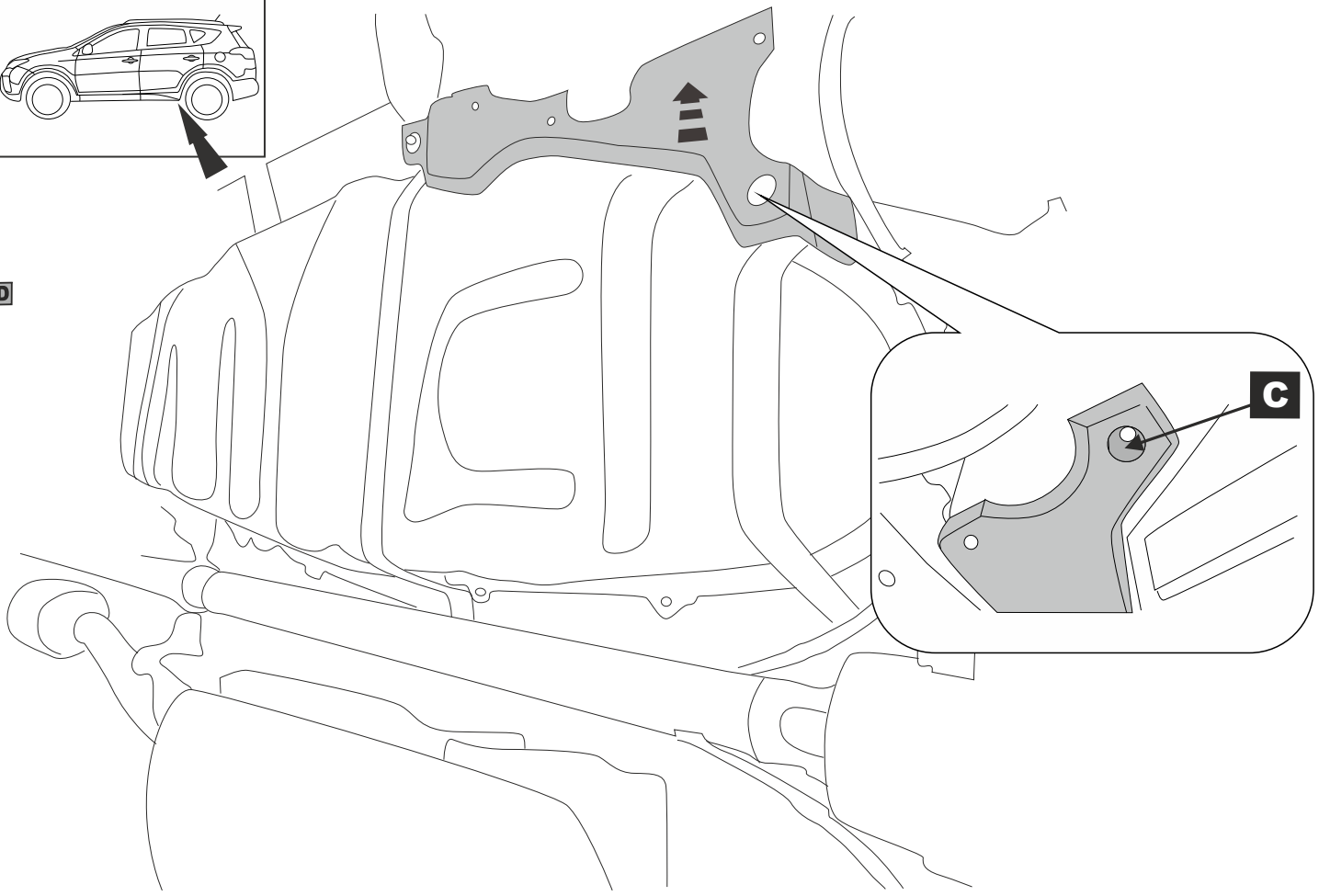

6

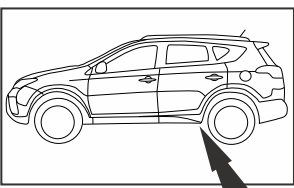

FWD

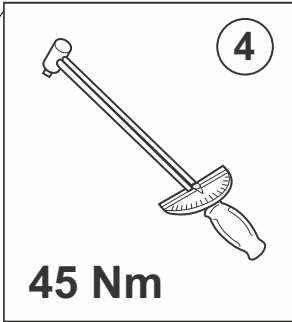
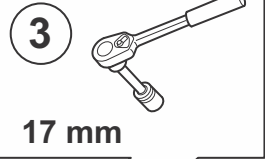

D

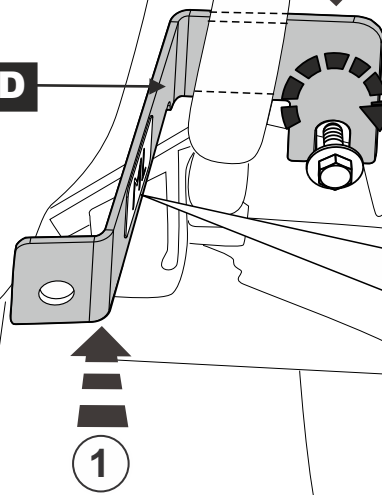

1



7

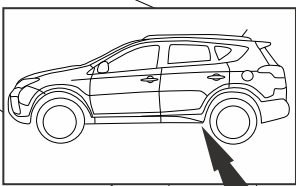

3

17 mm

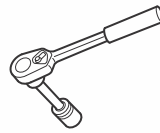

4

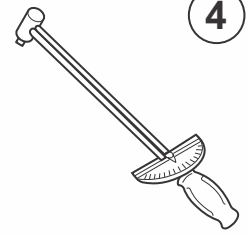

45 Nm

2



1



E



8

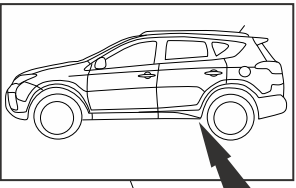

FWD

3

17 mm

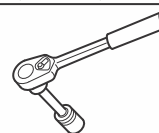

4

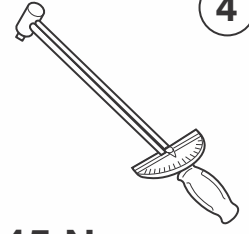

45 Nm

2



1



F



9

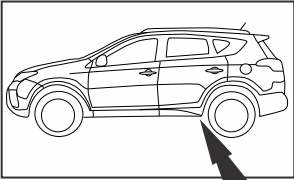

FWD



see repair manual



10

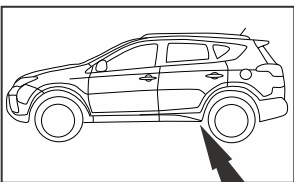

FWD

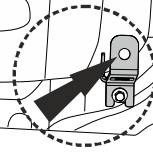
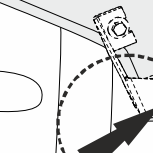
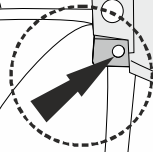
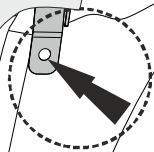

11

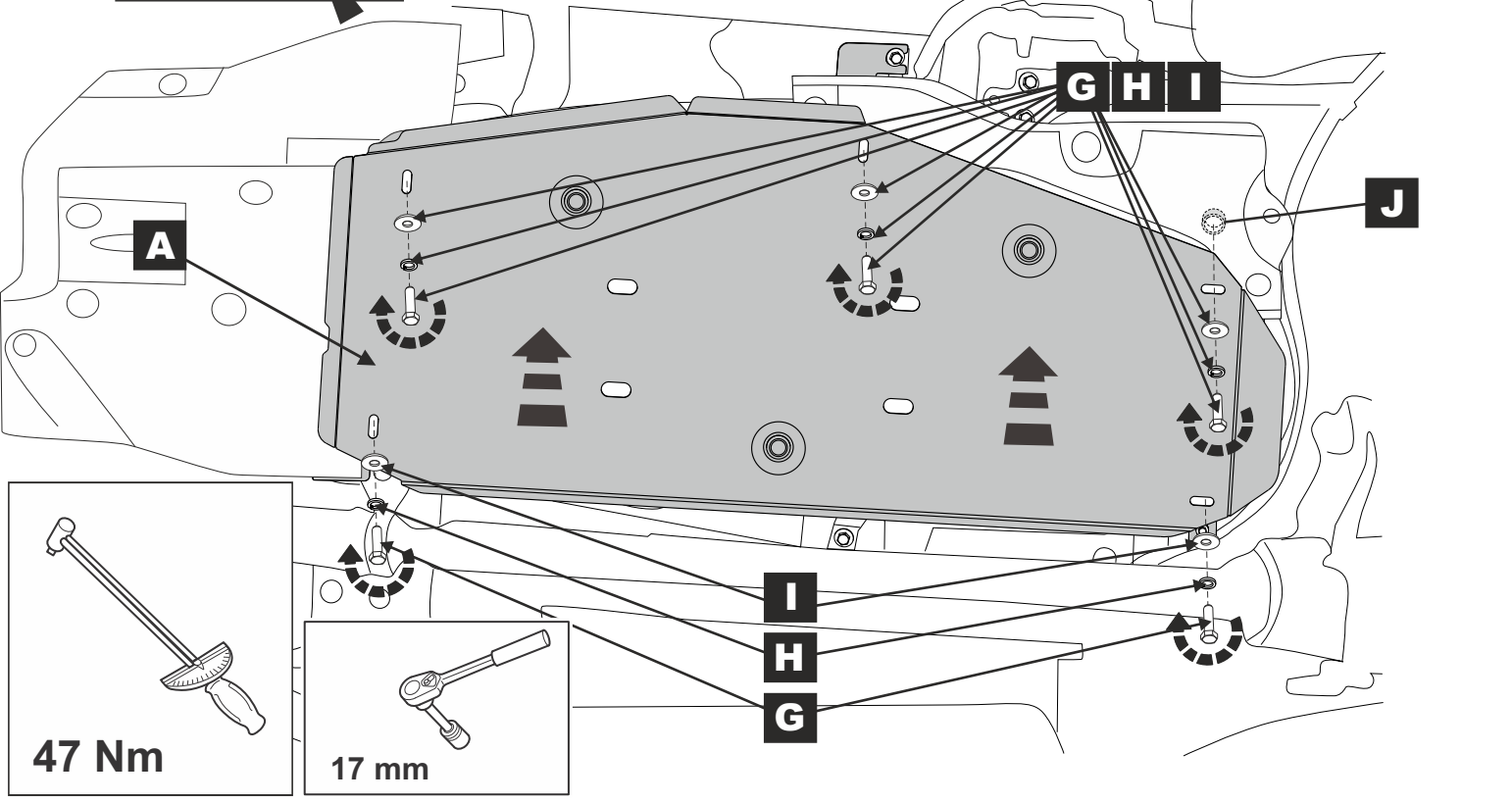
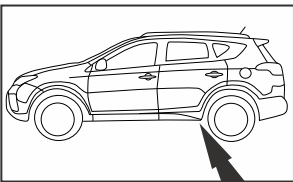

12

